



JARED JOYCE, INC.

# INVENTOR'S EXTRAS

[www.jaredjoyce.com](http://www.jaredjoyce.com)



A LADDER FOR THE APPLE TREE:

## THE IMPORTANCE OF NOT JUST PICKING THE LOW-HANGING FRUIT

For those of you wondering if every invention I've ever come up with is worth commercializing, the answer is an emphatic NO!

However, inventing isn't just about making money. Inventing is fun and any time that you can think of something that no one else has ever done it is an amazing rush. Even if you never conceive of an invention that is worth patenting I commend you all the same for having conceived of an invention at all.

The point of this discussion is to make clear that inventing as a career, inventing for money, requires discipline. I have a new idea pop into my head most every day, but only about one of every ten do I feel is worth taking to market.

However, sometimes the inventions are so much fun that I at least want to make one for myself. Forget about establishing funding, writing patents, and flying around the country to pitch the idea. I just want one to use for myself.

What follows are three such inventions pulled from the invention archives of Jared Joyce.

**SOLOFLEX  
WEIGHTSTRAP HOLDER**



**CD RACK**

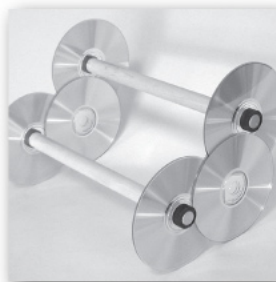

**PAINTSTICK HOLDER**





JARED JOYCE, INC.

# INVENTOR'S EXTRAS

www.jaredjoyce.com

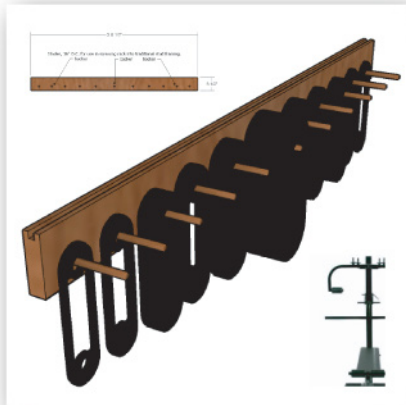

INVENTION ARCHIVES

## SOLOFLEX WEIGHTSTRAP HOLDER

When a person is working out on a Soloflex they use what are called 'weightstraps' which are much like large rubber bands that provide resistance during a workout. These weightstraps are changed out during each exercise and having them stored in the box of the manufacturer from which they arrived does not make for a very efficient change out process during a workout.



I designed a hanging system that allows each weightstrap to be stored within arm's reach of the Soloflex on either side of the machine. This design made not only for time saving function during a workout, but also an aesthetically pleasing display for when the Soloflex was not in use.

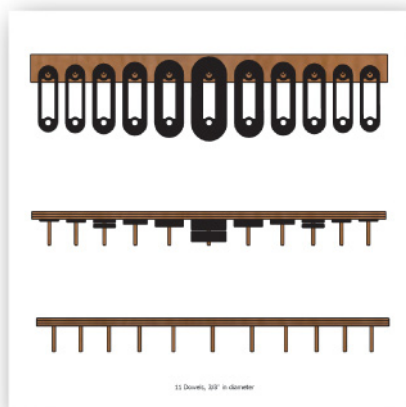



JARED JOYCE, INC.

# INVENTOR'S EXTRAS

[www.jaredjoyce.com](http://www.jaredjoyce.com)

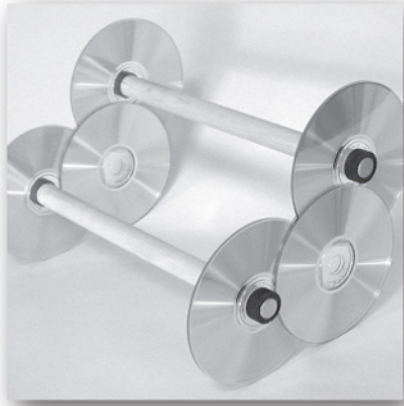

## INVENTION ARCHIVES CD RACK

When it comes to issues of storage I typically build my own custom solution. When the time came that I had accumulated an abundance of CDs I once again looked to create a better storage solution than what was available for purchase. My solution was not necessarily better, but it certainly was novel. I set out to make a CD rack, out of CDs.



This was also in the time of the dot com booms and I thought that I had struck on such a niche market that perhaps I could find some healthy sales online. My intent was to sell CD racks as a way to fund my inventions, however, within a few months of starting the website I realized that selling CD racks online was not the fast track way to getting my inventions to market.

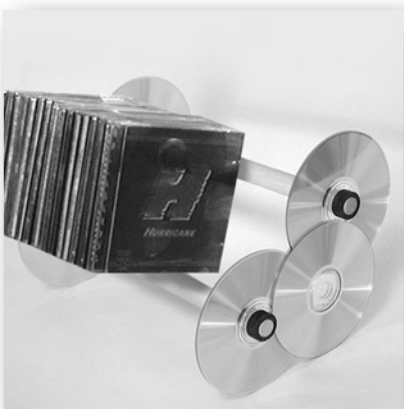



JARED JOYCE, INC.

# INVENTOR'S EXTRAS

www.jaredjoyce.com



## INVENTION ARCHIVES

### PAINTSTICK HOLDER

One summer my parents basement wall decided to leak and while I was visiting they decided to have me help seal the wall by painting it with Drylok®. For those of you who have ever stirred a can of Drylok® you know this is not your typical paint. The paint is so thick that I was actually developing red sores from the paintstick cutting into my hand while stirring.

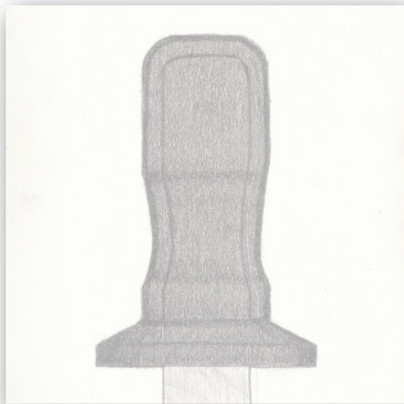

I initially thought of a handle only for use on thick paint, but when I used my paintstick handle in conjunction with regular paint I noticed quicker stir times and reduced fatigue due to greater control provided by the handle with its larger axis of rotation.

I thought about my handle being given away as a freebie just like paintsticks and paint can openers, but in the end I decided that with all of the expense to get my product to market it would only end up breaking even, and I don't go after inventions that only break even.

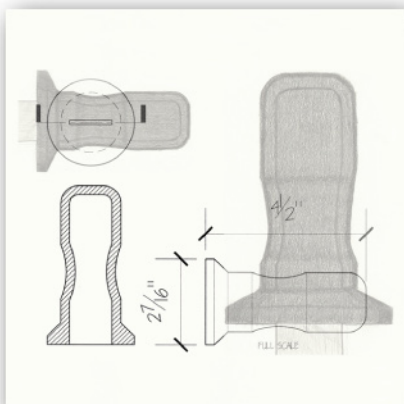

All the same, I have my paintstick handle which I use and enjoy for myself.